

Schottky rectifier

Features

- Low profile package
- Ideal for automated placement
- Ultrafast reverse recovery time
- Low power losses, high efficiency
- Low forward voltage drop
- High surge capability
- High temperature soldering: 260°C/10 seconds at terminals
- Component in accordance to RoHS 2002/95/1 and WEEE 2002/96/EC

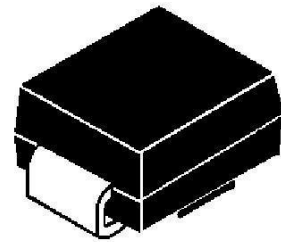

SMB (DO-214 AA)

Mechanical Data

- Case: JEDEC DO-214AA molded plastic
- Terminals: Solder plated, solderable per J-STD-002B and JESD22-B102D
- Polarity: Laser band denotes cathode end

Major Ratings and Characteristics

$I_{F(AV)}$	3.0A
V_{RRM}	20 V to 200 V
I_{FSM}	100A
V_F	0.50V, 0.55V, 0.70V, 0.85V, 0.95V
T_j max.	125 °C

Maximum Ratings & Thermal Characteristics ($T_A = 25\text{ °C}$ unless otherwise noted)

Items	Symbol	SS32B	SS33B	SS34B	SS35B	SS36B	SS38B	SS310B	SS315B	SS320B	UNIT
Maximum repetitive peak reverse voltage	V_{RRM}	20	30	40	50	60	80	100	150	200	V
Maximum RMS voltage	V_{RMS}	14	21	28	35	42	56	70	105	140	V
Maximum DC blocking voltage	V_{DC}	20	30	40	50	60	80	100	150	200	V
Maximum average forward rectified current	$I_{F(AV)}$	3									A
Peak forward surge current 8.3ms single half sine-wave superimposed on rated load	I_{FSM}	100									A
Voltage rate of change(rated VR)	dv/dt	10000									V/ μ s
Thermal resistance from junction to lead	$R_{\theta JL}$	25									°C/W
Operating junction and storage temperature range	T_J, T_{STG}	-65 to +125									°C

Electrical Characteristics ($T_A = 25\text{ }^\circ\text{C}$ unless otherwise noted)

Items	Test conditions	Symbol	SS32B	SS33~34B	SS35~36B	SS38~310B	SS315~320B	UNIT
Instantaneous forward voltage	$I_F=3.0\text{A}$	V_F	0.50	0.55	0.70	0.85	0.95	V
Reverse current	$V_R=V_{DC}$	$T_j=25\text{ }^\circ\text{C}$	0.5					mA
		$T_j=100\text{ }^\circ\text{C}$	5.0					

Characteristic Curves ($T_A=25\text{ }^\circ\text{C}$ unless otherwise noted)

Fig 1. Forward Current Derating Curve

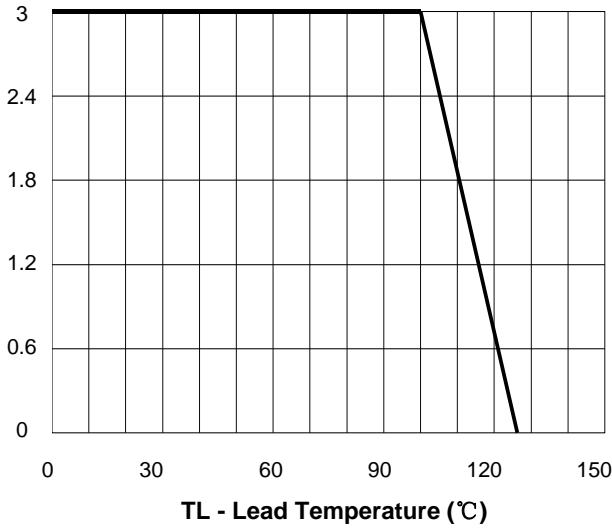

Fig 2. Maximum Non-Repetitive Peak Forward Surge Current

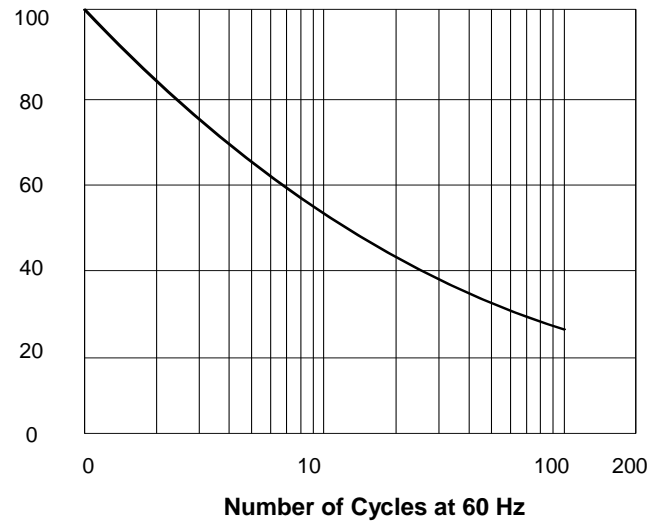

Fig 3. Typical Instantaneous Forward

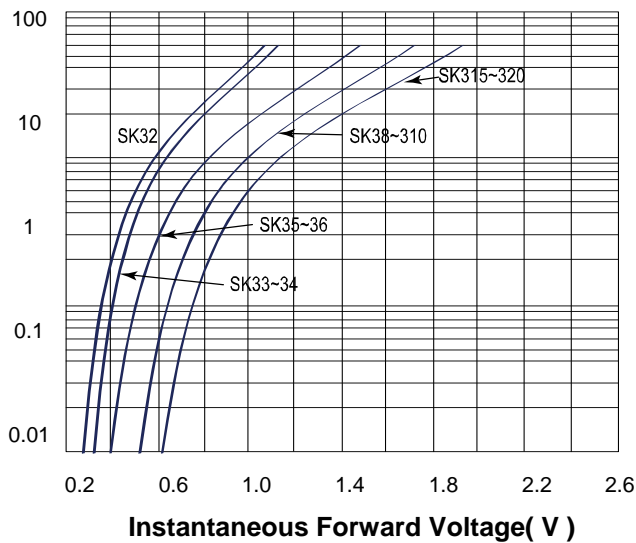
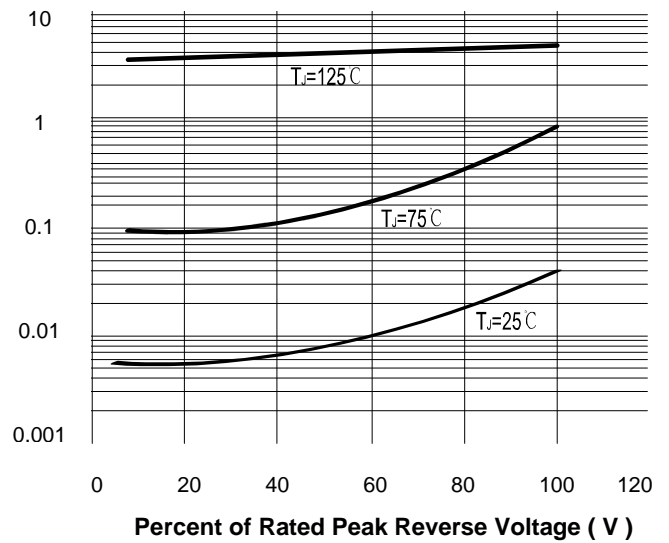
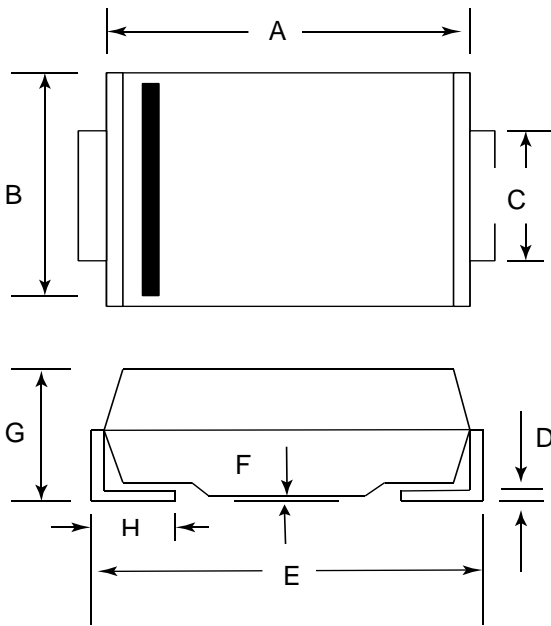

Fig 4. Typical Reverse Leakage Characteristics



Package Dimensions



Dim	Millimeters		Inches	
	Min	Max	Min	Max
A	4.06	4.57	0.160	0.180
B	3.30	3.94	0.130	0.155
C	1.78	2.20	0.070	0.086
D	0.13	0.31	0.006	0.012
E	5.08	5.59	0.200	0.220
F	----	0.20	----	0.008
G	1.95	2.62	0.077	0.103
H	0.76	1.52	0.030	0.060

Suggested Land Pattern

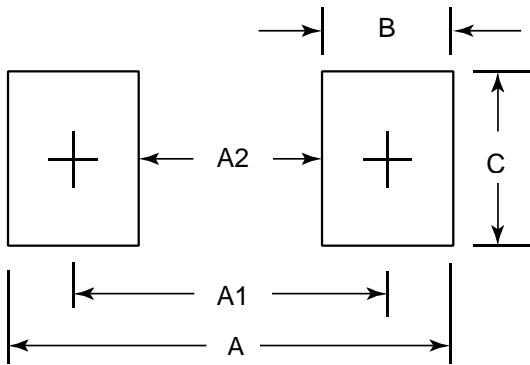

DIM	Millimeters
A	6.58
A1	4.42
A2	2.26
B	2.16
C	2.75