

1-Line Bi-directional TVS Diode

Description

The PESDU0511D5N is designed to protect voltage sensitive components from ESD and transient voltage events. The PESDU0511D5N complies with the IEC 61000-4-2 (ESD) standard with $\pm 30\text{kV}$ air and $\pm 30\text{kV}$ contact discharge. Excellent clamping capability, low leakage, and fast response time make these parts ideal for ESD protection on designs where board space is at a premium.

Features

- Reverse stand-off voltage: 5.0V Max
- Low leakage current: nA level
- Low Clamping Voltage
- Response time is typically $< 1\text{ ns}$
- Complies with following standards:
 - IEC 61000-4-2 (ESD) immunity test
 - Air discharge: $\pm 30\text{kV}$
 - Contact discharge: $\pm 30\text{kV}$
 - IEC 61000-4-5 (Lightning) 5.0A (8/20 μs)
- RoHS Compliant

Schematic and Pin Configuration

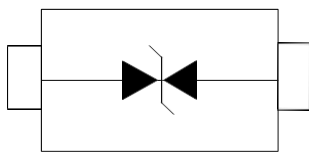

Graphic symbol

Mechanical Characteristics

- Package: SOD-523
- Case Material: “Green” Molding Compound.
- Moisture Sensitivity: Level 1 per J-STD-020
- Marking Information: See Below

Applications

- Cellular phones
- Portable devices
- Digital Cameras
- Power supplies

Marking Information

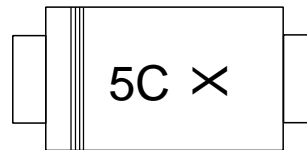

5C X = Device Marking Code

Ordering Information

Part Number	Shipping	Reel Size
PESDU0511D5N	3000/Tape & Reel	7 inch

Absolute Maximum Ratings (T_A=25°C unless otherwise specified)

Parameter	Symbol	Value	Unit
Peak Pulse Power (8/20μs)	P _{pk}	80	W
Peak Pulse Current (8/20μs)	I _{PP}	5.0	A
ESD per IEC 61000-4-2 (Air)	V _{ESD}	±30	kV
ESD per IEC 61000-4-2 (Contact)		±30	
Lead temperature	T _L	260	°C
Operating Temperature Range	T _{OP}	-40 ~ +85	°C
Storage Temperature Range	T _{STG}	-55 ~ +150	°C

Electrical Characteristics (T_A=25°C unless otherwise specified)

Parameter	Symbol	Min	Typ	Max	Unit	Test Condition
Reverse Working Voltage	V _{RWM}			5.0	V	
Breakdown Voltage	V _{BR}	5.6			V	I _T = 1mA
Reverse Leakage Current	I _R			100	nA	V _{RWM} = 5.0V
Clamping Voltage	V _C			16	V	I _{PP} = 5.0A (8/20μs pulse),
Junction Capacitance	C _J		18		pF	V _R = 0V, f = 1MHz

Electrical characteristics ($T_A = 25^\circ\text{C}$, unless otherwise noted)

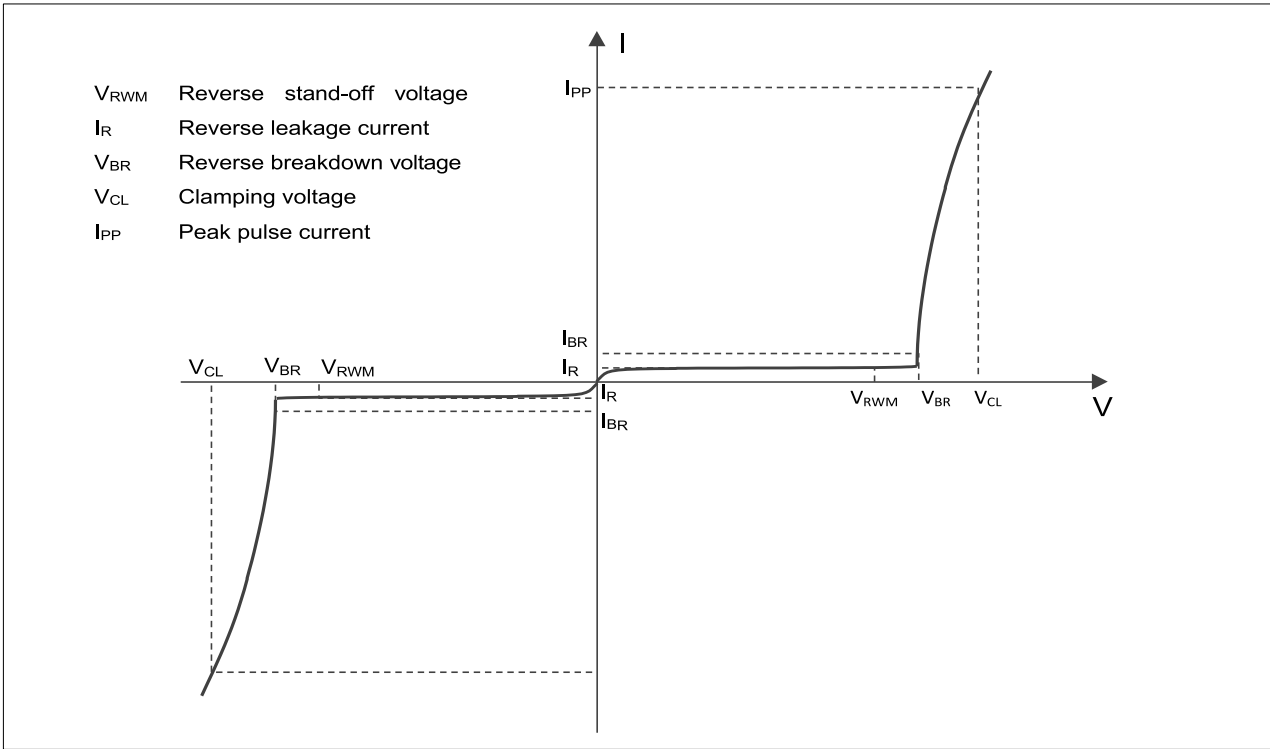

Definitions of electrical characteristics

Typical Performance Characteristics (T_A=25°C unless otherwise Specified)

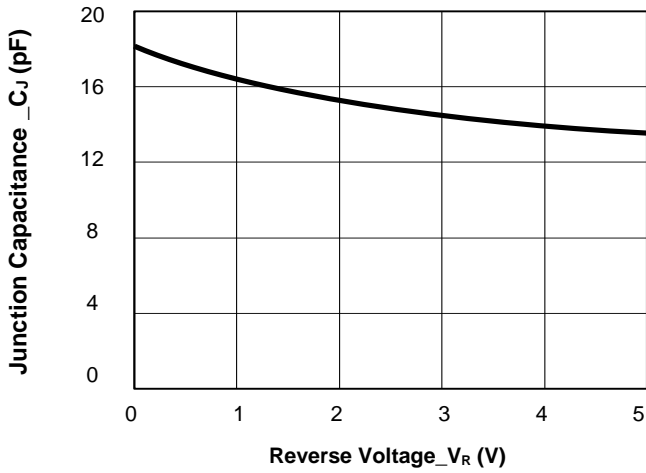

Junction Capacitance vs. Reverse Voltage

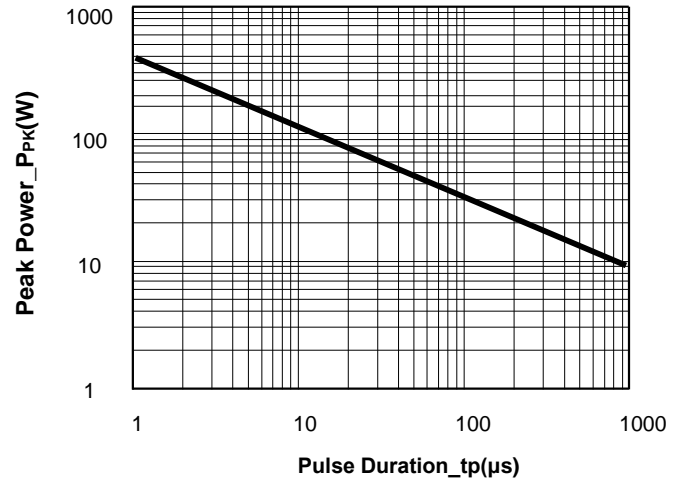

Peak Pulse Power vs. Pulse Time

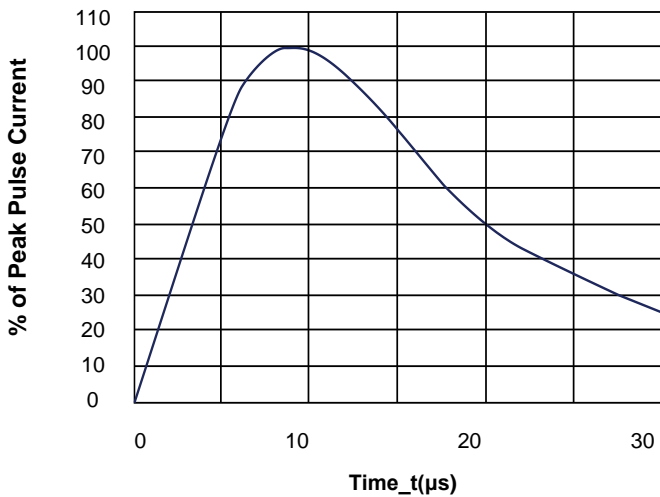

8/20μs Pulse Waveform

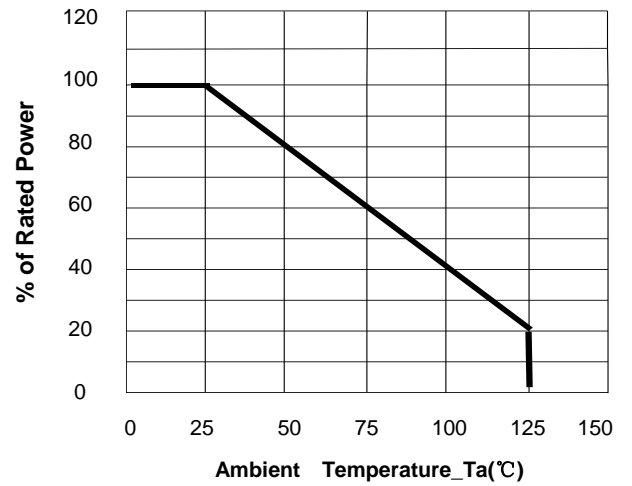

Power Derating Curve

SOD523 Package Outline Drawing

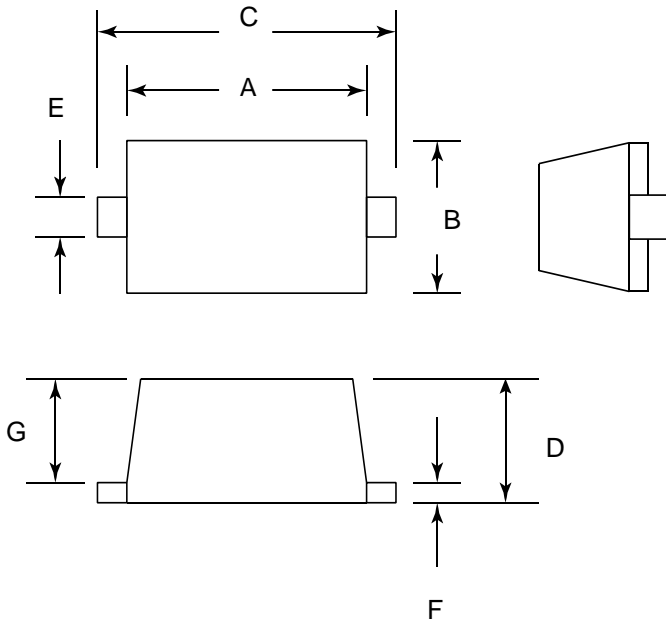

SYM	DIMENSIONS			
	MILLIMETERS		INCHES	
	MIN	MAX	MIN	MAX
A	1.10	1.30	0.043	0.051
B	0.70	0.90	0.028	0.035
C	1.50	1.70	0.059	0.067
D	0.50	0.70	0.020	0.028
E	0.25	0.35	0.010	0.014
F	0.10	0.20	0.004	0.008
G	0.50	0.70	0.020	0.028

Suggested Land Pattern

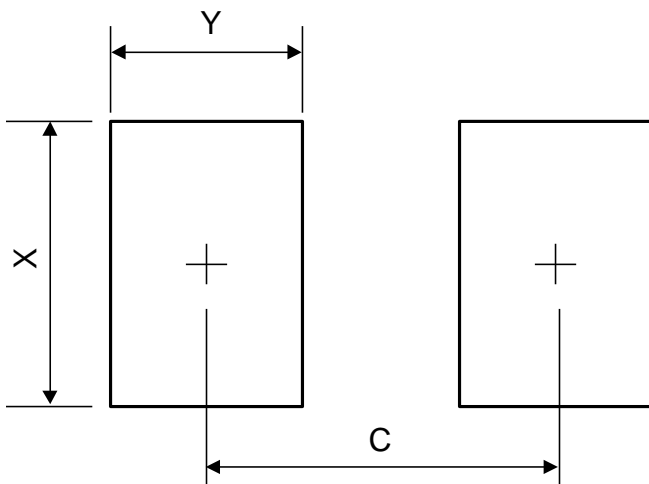

SYM	DIMENSIONS	
	MILLIMETERS	INCHES
C	1.42	0.056
X	0.70	0.028
Y	0.60	0.024

TAPE AND REEL INFORMATION

Reel Dimensions

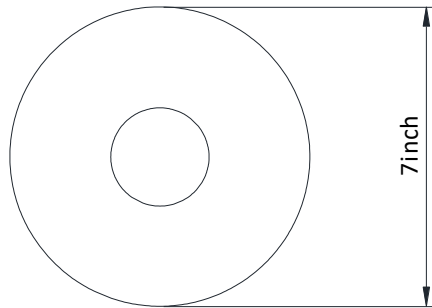

Tape Dimensions

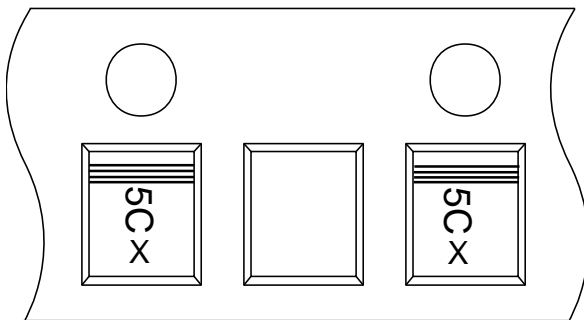
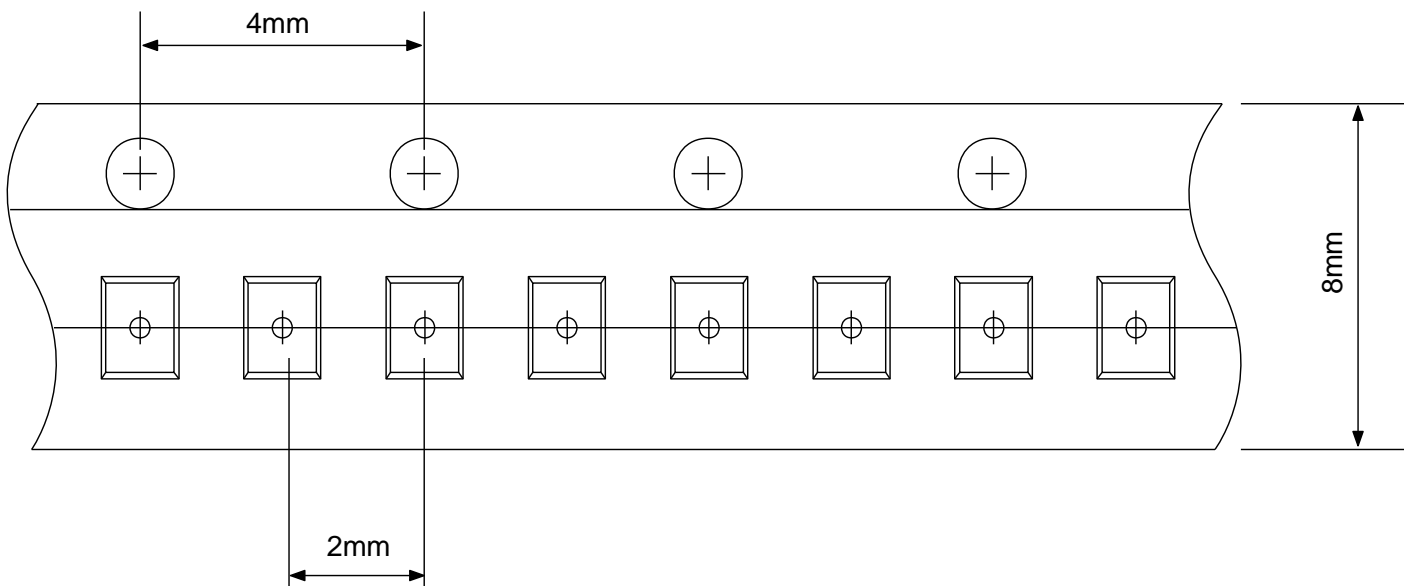

User Direction of Feed

IMPORTANT NOTICE

The information given in this document is believed to be accurate and reliable but shall in no event be regarded as a guarantee of conditions or characteristics. PN-Silicon assumes no responsibility for any errors in this document, or for the consequences of use of such information nor for any infringement of patents or other rights of third parties which may result from its use. No license is granted by implication or otherwise under any patent or patent rights of PN-Silicon.

The product listed in this document are designed to be used with ordinary electronic equipment or devices and are not authorized to used with equipment or devices which require an extremely high level of reliability and the malfunction of with would directly endanger human life (such as medical instruments, aerospace machinery, nuclear-reactor controllers, automotive and other safety device.)

The **PN SILICON** logo is a registered trademark of PN-Silicon co., ltd which reserves the right to make changes to the product or this document at any time without notice. Buyers should obtain the latest relevant information before placing orders and should verify that such information is current and complete. PN-Silicon makes no warranty, representation or guarantee, express or implied, regarding the suitability of its products for any particular purpose. All rights reserved.