

2-Line Uni-directional ESD Protection Diode

Description

These dual monolithic silicon surge protection diodes are designed for applications requiring transient overvoltage protection capability. They are intended for use in voltage and ESD sensitive equipment. as computers, printers, business machines, communication systems, medical equipment and other applications. Their Uni-directional double ESD design protects two separate lines using only one package. These devices are ideal for situations where board space is at a premium.

Features

- Uni-directional ESD protection of two line
- Reverse stand-off voltage: 12.0V Max
- Low clamping voltage
- Low leakage current:nA level
- Response time is typically < 1 ns
- Complies with following standards:
 - IEC 61000-4-2 (ESD) immunity test
 - Air discharge: ±30kV
 - Contact discharge: ±30kV
 - IEC61000-4-5 (Lightning) 10A (8/20µs)
- RoHS Compliant

Schematic and Pin Configuration

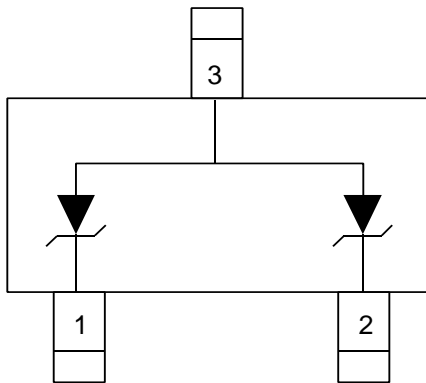

Circuit and Pin Schematic

Mechanical Characteristics

- Package: SOT-23
- Case Material: “Green” Molding Compound
- We declare that the material of product compliance with RoHS requirements and Halogen Free

Applications

- Computers
- Printers
- Communication systems
- Cellular Handsets and Accessories
- Portable Electronics
- Industrial Controls

Marking Information

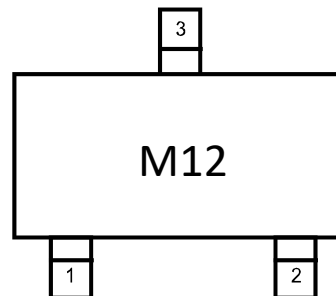

M12 = Device Marking Code

Ordering Information

Part Number	Shipping	Reel Size
PSM12	3000/Tape &Reel	7 inch

Absolute Maximum Ratings ($T_A=25^{\circ}\text{C}$ unless otherwise specified)

Parameter	Symbol	Value	Unit
Peak Pulse Power (8/20 μs)	P_{PK}	280	W
Peak Pulse Current (8/20 μs)	I_{PP}	10	A
ESD per IEC 61000-4-2 (Air)	V_{ESD}	± 30	kV
ESD per IEC 61000-4-2 (Contact)		± 30	kV
Lead temperature	T_L	260	$^{\circ}\text{C}$
Operating Temperature Range	T_{OP}	-40 ~ +85	$^{\circ}\text{C}$
Storage Temperature Range	T_{STG}	-55 ~ +150	$^{\circ}\text{C}$

Electrical Characteristics ($T_A=25^{\circ}\text{C}$ unless otherwise specified)

Parameter	Symbol	Min	Typ	Max	Unit	Test Condition
Reverse Working Voltage	V_{RWM}			12.0	V	
Reverse Breakdown Voltage	V_{BR}	13.5		16.0	V	$I_T = 1\text{mA}$
Reverse Leakage Current	I_R			0.1	μA	$V_{RWM} = 12.0\text{V}$
Clamping Voltage	V_C			17	V	$I_{PP} = 1\text{A}$ (8/20 μs pulse)
Clamping Voltage	V_C			28	V	$I_{PP} = 10\text{A}$ (8/20 μs pulse)
Junction Capacitance	C_J		60	80	pF	$V_R = 0\text{V}$, $f = 1\text{MHz}$ (Pin1 or Pin2 to Pin3)
			30	40		$V_R = 0\text{V}$, $f = 1\text{MHz}$ (Pin1 to Pin2 or Pin2 to Pin1)

Electrical characteristics ($T_A = 25^\circ\text{C}$, unless otherwise noted)

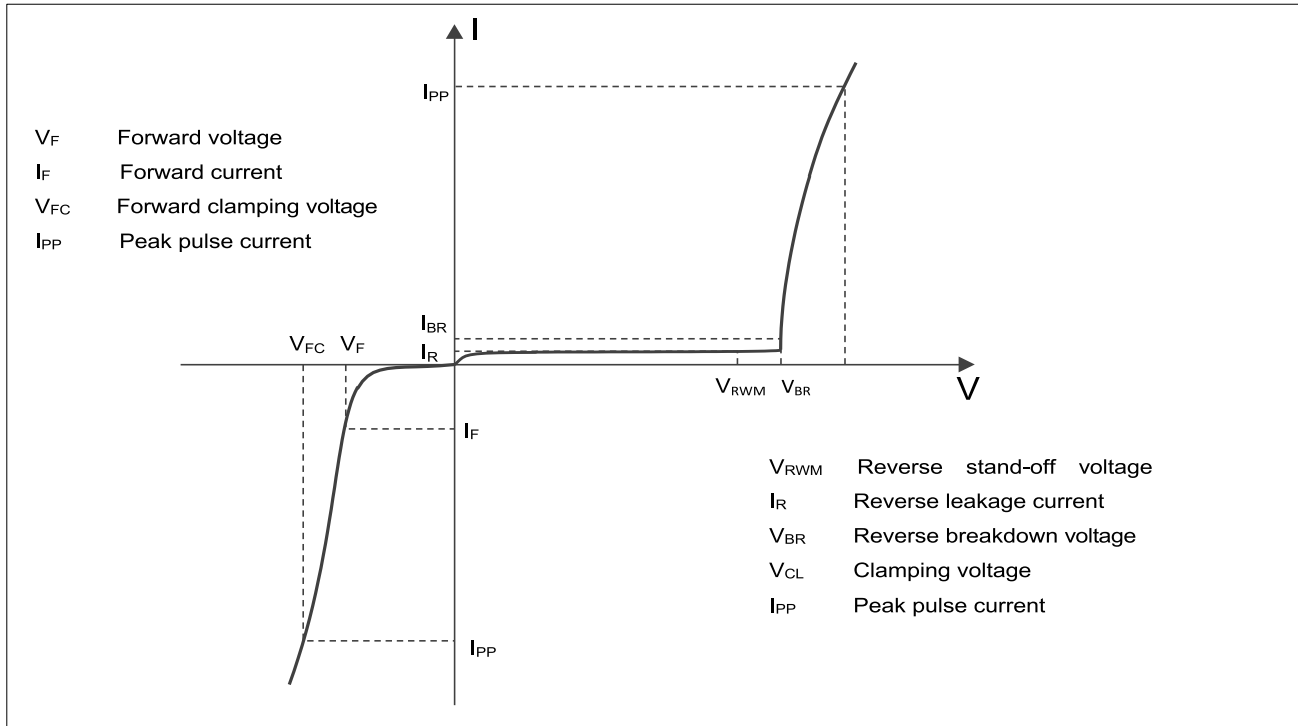

Definitions of electrical characteristics

Typical Performance Characteristics (T_A=25°C unless otherwise Specified)

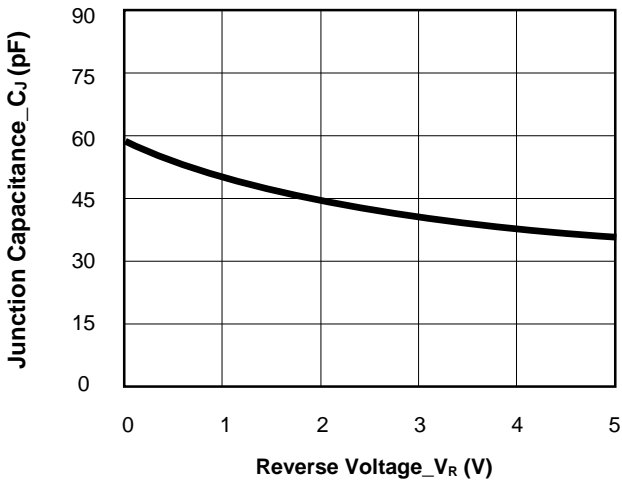

Junction Capacitance vs. Reverse Voltage

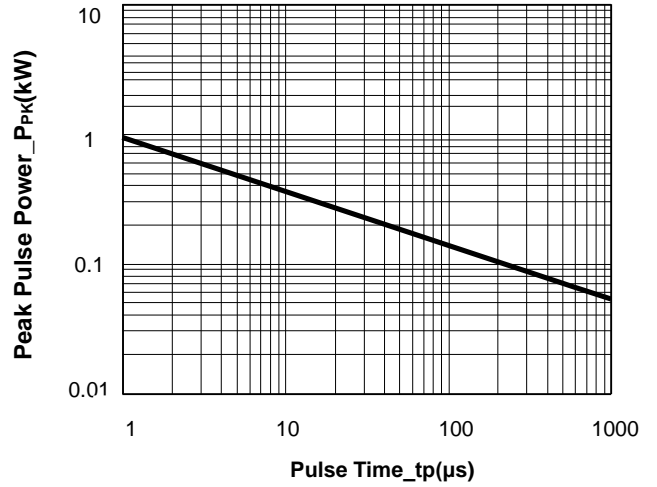

Peak Pulse Power vs. Pulse Time

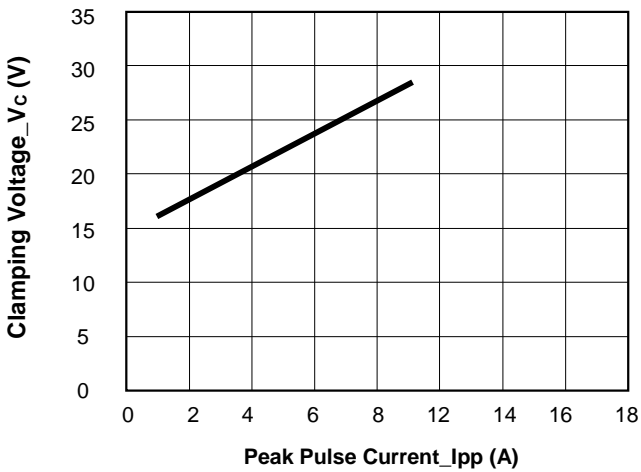

Clamping Voltage vs. Peak Pulse Current

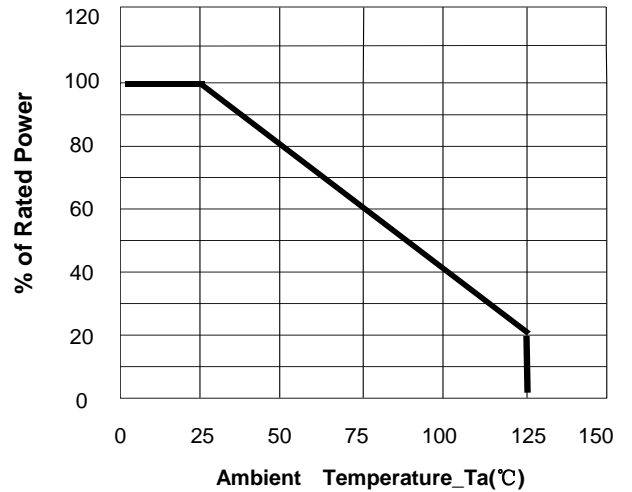

Power Derating Curve

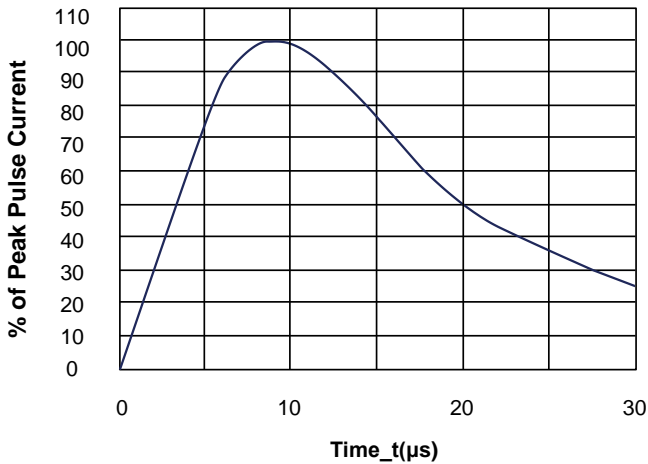

8/20 μs Pulse Waveform

SOT-23 Package Outline Drawing

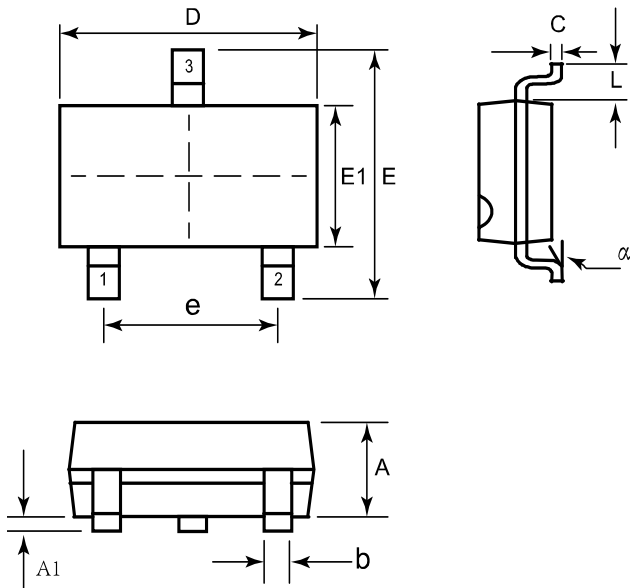

SYM	DIMENSIONS					
	INCHES			MILLIMETERS		
	MIN	NOM	MAX	MIN	NOM	MAX
A	0.035	0.037	0.040	0.88	0.95	1.02
A1	0.000	-	0.004	0.01	-	0.10
b	0.012	-	0.020	0.30	-	0.51
C	0.003	-	0.007	0.08	-	0.18
D	0.110	0.114	0.120	2.80	2.90	3.04
E	0.082	0.093	0.104	2.10	2.37	2.64
E1	0.047	0.051	0.055	1.20	1.30	1.40
e	0.075 BSC			1.90 BSC		
L	0.022 BSC			0.55 BSC		
α	0°		8°	0°		8°

Suggested Land Pattern

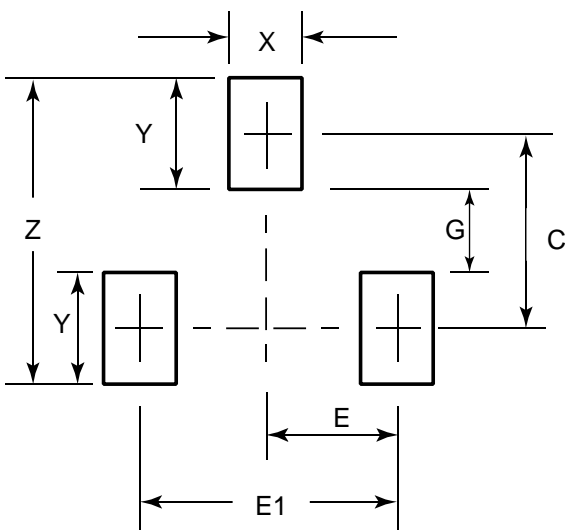

SYM	DIMENSIONS	
	MILLIMETERS	INCHES
C	2.20	0.087
E	0.95	0.037
E1	1.90	0.075
G	0.80	0.031
X	1.00	0.039
Y	1.40	0.055
Z	3.60	0.141

TAPE AND REEL INFORMATION

Reel Dimensions

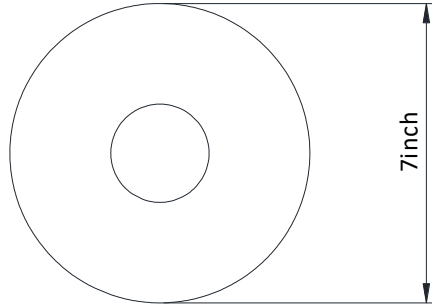

Tape Dimensions

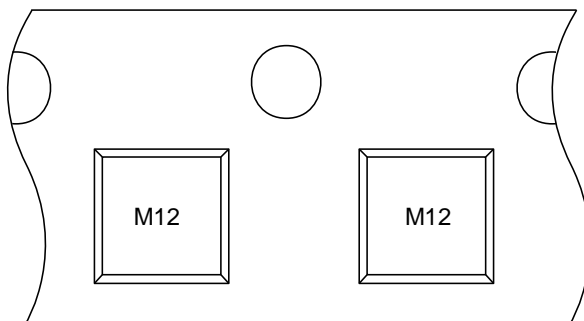
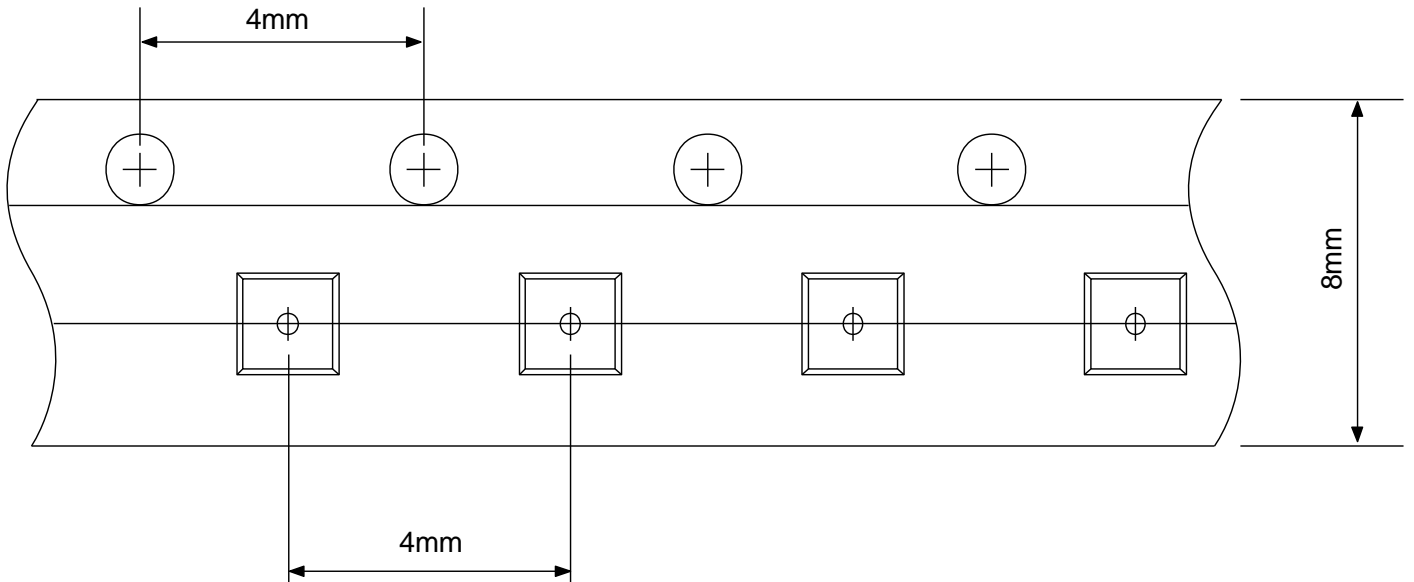

User Direction of Feed

IMPORTANT NOTICE

The information given in this document is believed to be accurate and reliable but shall in no event be regarded as a guarantee of conditions or characteristics. PN-Silicon assumes no responsibility for any errors in this document, or for the consequences of use of such information nor for any infringement of patents or other rights of third parties which may result from its use. No license is granted by implication or otherwise under any patent or patent rights of PN-Silicon.

The product listed in this document are designed to be used with ordinary electronic equipment or devices and are not authorized to used with equipment or devices which require an extremely high level of reliability and the malfunction of with would directly endanger human life (such as medical instruments, aerospace machinery, nuclear-reactor controllers, automotive and other safety device.)

The  logo is a registered trademark of PN-Silicon co., ltd which reserves the right to make changes to the product or this document at any time without notice. Buyers should obtain the latest relevant information before placing orders and should verify that such information is current and complete. PN-Silicon makes no warranty, representation or guarantee, express or implied, regarding the suitability of its products for any particular purpose. All rights reserved.